

Yealink

T33G



i·letcarrier™

Package Contents

The following items are included in your package.

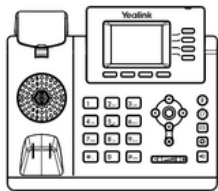

Phone



Handset



Handset
Cord



Ethernet Cable
(2m CAT5E FTP
Cable)



Stand

1. Attach the stand and adjust the angle of the screen

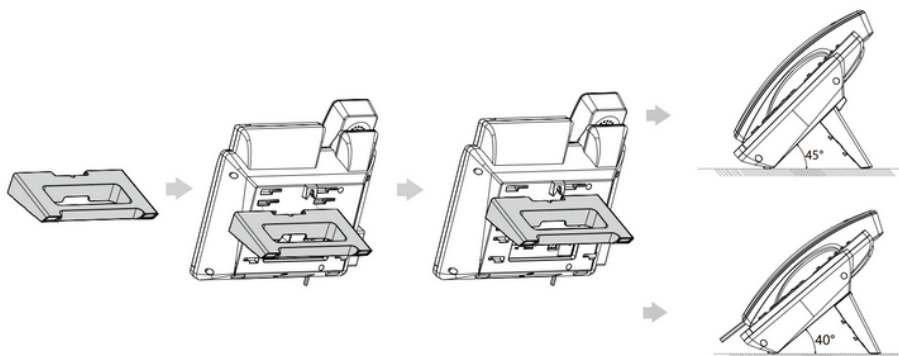

2. Connect the handset and optional headset

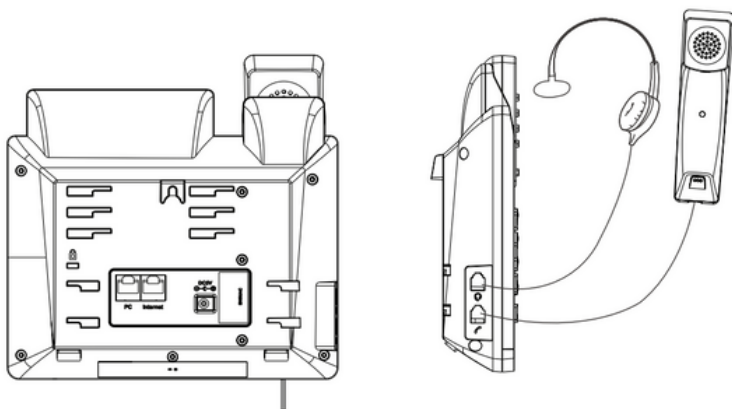

3. Connect the network and power

You have two options for network and power connections. NetCarrier will advise you which one to use.

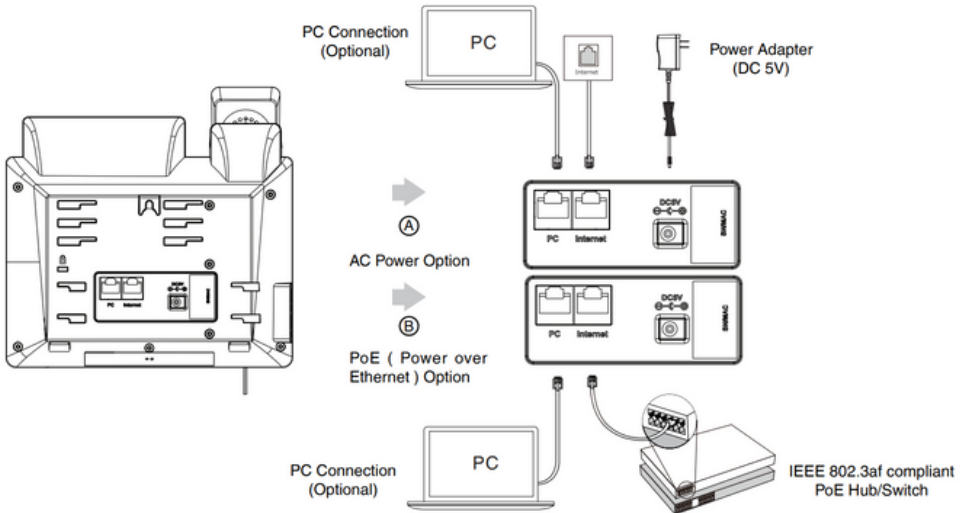

Note: The IP phone should be used with Yealink original power adapter (5V/2A) only. The use of the third-party power adapter may cause the damage to the phone. If you are connecting a PC to your phone, we recommend that you use the Ethernet cable provided by Yealink. If inline power (PoE) is provided, you don't need to connect the power adapter. Make sure the hub/switch is PoE-compliant.

Starting the Phone

After the phone is connected to the network and supplied with power, it automatically begins the initialization process. After startup, the phone is ready for use.

Welcome
Initializing... Please wait

Using Basic Call Functions

Placing a Call

Using the handset:

1. Pick up the handset.
2. Enter the number, and then press **Send**.

Using the speakerphone:

1. With the handset on-hook, press .
2. Enter the number, and then press **Send**.

Using the headset:

1. With the headset connected, press  to activate the headset mode
2. Enter the number, and then press **Send**

Note: During a call, you can alternate between the headset, hands-free speakerphone and handset modes by pressing the **HEADSET** key, the **SPEAKERPHONE** key or by picking up the handset. Headset mode requires a connected headset.

Answering a Call

Using the handset:

Pick up the handset.

Using the speakerphone:

Press .

Using the headset:

Press .

Note: You can reject an incoming call by pressing **Reject**

Ending a Call

Using the handset:

Hang up the handset or press **End Call**.



Using the speakerphone:

Press  or **End Call**.



Using the headset:

Press **End Call**.

Redialing a Call

- Press  to enter the **Placed Calls** list, select the desired entry, and press  or the **Send** soft key.
- Press  twice when the phone is idle to dial out the last dialed number.

Muting and Un-muting a Call

- Press  to mute the microphone during a call.
- Press  again to un-mute the call.

Holding and Resuming a Call

To Hold a call:

Press the **Hold** soft key during an active call.

To Resume the call, do one of the following:

- If there is only one call on hold, press the **Resume** soft key.
- For more than one call on hold, select the desired call, and press the **Resume** soft key.

Transferring a Call

You can transfer a call in the following ways:

Performing a Blind Transfer

- 1.Press the **Trans** soft key during an active call.
2. Enter the number you want to transfer to.
- 3.Press the **B Trans** soft key.

Performing a Semi-Attended Transfer

- 1.Press the **Trans** soft key during an active call.
2. Enter the number you want to transfer to, and then press the **Send** soft key.
- 3.Press the **Trans** soft key when you hear the ring-back tone.

Performing a Attended Transfer

- 1.Press the **Trans** soft key during an active call.
2. Enter the number you want to transfer to, and then press the **Send** soft key.
- 3.Press the **Trans** soft key when the second party answers.

Initiating a Conference Call

1. Press the **Conf** soft key during an active call. The call is placed on hold.
2. Enter the number of the second party, and then press the **Send** soft key.
3. Press the **Conf** soft key again when the second party answers. All three parties are now joined in the conference.

Note: You can split the conference call into two individual calls by pressing **Split**

To use the speed dial key:

Press the speed dial key to dial out the preset number.

Listening to Voice Mails



Message waiting indicator on the idle screen indicates that one or more voicemail messages are waiting at the message center. The power indicator LED slowly flashes red.

To listen to voice mails:

- 1.Press  or the **Connect** soft key.
2. Follow the voice prompts to listen to your voicemail messages.

Customizing Your Phone

Managing Call History

1. Press the **History** soft key when the phone is idle.
2. Press  or  to select an entry from the list.
3. Do the following:
 - Press **Send** to call the entry.
 - Press **Delete** to delete the entry from the list.
 - Press **Option**, you can do the following:
 - Select **Detail** to view detailed information about the entry.
 - Select **Add to Contacts** to add the entry to the local directory.
 - Select **Add to Blacklist** to add the entry to the blacklist.
 - Select **Delete All** to delete all entries from the list.

Adjusting the Volume

Press  to adjust the volume.